

Kleinburg Glen - 14 - 2 - 38-1 Elev.B HAMPTON

CENTRAL VAC AND WIRING

Inv.1,200	1 - BEDROOM 4: Relocate STD Cable from Master Bedroom to Bedroom 4
Line19487	Note: See floorplan for location
21Feb17 / 26Oct17	

CERAMIC

Inv.1,200	1 - MASTER ENSUITE Floor Tile: UPG 5 -24x24
Line19500	Note:
21Feb17 / 26Oct17	

Inv.1,200	1 - MASTER ENSUITE Shower Wall Tile: UPG 1 - 4x16"
Line19502	Note: Installed horizontally stacked
21Feb17 / 26Oct17	

Inv.1,200	1 - ENSUITE 2 Floor Tile: UPG 4 - 12x24"
Line19514	Note: Layed Horizontally stacked - see floorplan for direction
21Feb17 / 26Oct17	

Inv.1,200	1 - ENSUITE 3/4 Floor Tile: UPG 4 - 12x24"
Line19515	Note: Layed in a vertical stacked pattern - see floorplan for tile direction
21Feb17 / 26Oct17	

Inv.1,200	1 - ENSUITE 2 Shower Wall Tile: UPG 2 Mosaic
Line19518	Note:
21Feb17 / 26Oct17	

Inv.1,200	1 - TWIN BATH Shower Wall Tile: UPG 2 Mosaic
Line19519	Note:
21Feb17 / 26Oct17	

Inv.1,200	1 - UPGRADE TO FREE STANDING TUB - UPG1 ONLY
Line23208	Note:
21Feb17 / 26Oct17	

ELECTRICAL

Inv.1,200	1 - KITCHEN: Rough in ceiling light on same switch- Capped (doesn't include fixture)
Line17803	Note: Over island. Right side. Please see floorplan for location
21Feb17 / 26Oct17	

Inv.1,200	1 - KITCHEN: Relocate Standard Kitchen ceiling light above island, left side. See floorplan for location
Line17805	Note:
21Feb17 / 26Oct17	

Inv.1,200	19 - MAIN FLOOR Pot Light 3" LED
Line17810	Note: Please see floorplan for location
21Feb17 / 26Oct17	

Inv.1,200	1 - GARAGE: Additional Interior Single Pole Switch FOR EXTERIOR POT LIGHTS
Line19900	Note:
21Feb17 / 26Oct17	

Inv.1,200	2 - MAIN FLOOR: Additional Interior Switch
Line17811	Note: Please see floorplan for locations. 1 for Kitchen Potlights / 1 for Great Room Potlights.
21Feb17 / 26Oct17	

Kleinburg Glen - 14 - 2 - 38-1 Elev.B HAMPTON

Inv.1,200	6 - SECOND FLOOR: Delete standard hallway light and add Pot Light 4" LED Interior (Insulated) - Price per potlight. All on same switch
Line17815	Note: 4-way - see line item #13
21Feb17 / 26Oct17	

Inv.1,200	4 - EXTERIOR: Add 4 soffit LED 4" potlights
Line19491	Note: See Drawing for location
21Feb17 / 26Oct17	

Inv.1,200	1 - GREAT ROOM: Add 110V receptacle next to Cable Approx 55" AFF
Line19485	Note:
21Feb17 / 26Oct17	

Inv.1,200	1 - SECOND FLOOR: Additional Interior 4 way Switch For hallway pot lights - see floorplan for locations
Line19488	Note:
21Feb17 / 26Oct17	

Inv.1,200	1 - MASTER BEDROOM: Additional Interior Single Pole Switch FOR POTLIGHTS
Line19490	Note:
21Feb17 / 26Oct17	

Inv.1,200	1 - TWIN BATH- SHOWER IN LIEU OF TUB – FRAMED GLASS WITH POTLIGHT
Line23211	Note:
21Feb17 / 26Oct17	

Inv.1,263	1 - CREDIT ON CLOSING FOR: MASTER BEDROOM: Additional Interior Single Pole Switch FOR *NEW* POTLIGHTS. LINE ITEM #10 FROM INVOICE # PE1200-1
Line21235	Note:
21Mar17 / 6Dec17	

Inv.1,656	1 - KITCHEN: SEE *REVISED PLAN* FOR NEW LOCATION OF POTLIGHTS AND OVEN AND *NEW* FRIDGE
Line24824	Note: SEE PLAN FOR LOCATION
27Nov17 / 6Dec17	

Inv.1,656	2 - DINING ROOM: ADD 2 POT LIGHTS: 4 INCH POT LIGHT - PRICED PER LIGHT - 10 OR *NEW* MORE
Line24827	Note: LOCATE POTLIGHTS APPROX. 24" ON EITHER SIDE OF STANDARD CAPPED CEILING LIGHT. SEE PLAN FOR LOCATION
27Nov17 / 6Dec17	

Inv.1,656	1 - DINING ROOM: Additional Interior Single Pole Switch - FOR POTLIGHTS IN DINING ROOM *NEW*
Line24830	Note: LOCATE SWITCH BESIDE STANDARD CEILING LIGHT SWITCH
27Nov17 / 6Dec17	

Exterior Colours

Inv.1,200	1 - EXTERIOR COLOUR PACKAGE #1
Line24534	Note:
21Feb17 / 26Oct17	

FRAMING

Inv.1,200	1 - MAIN FLOOR: EXTEND ARCHWAYS - NOTE
Line21234	Note:
21Feb17 / 26Oct17	

Inv.1,200	1 - MAIN FLOOR: EXTENDED HEIGHT ARCHWAY (PRICE PER DOORWAY) - INCLUDE FRAMING NOTE
Line23206	Note:
21Feb17 / 26Oct17	

Kleinburg Glen - 14 - 2 - 38-1 Elev.B HAMPTON

Inv.1,200	1 - UPGRADE TO FREE STANDING TUB - UPG1 ONLY
Line23207	Note:
21Feb17 / 26Oct17	

Inv.1,200	1 - TWIN BATH- SHOWER IN LIEU OF TUB – FRAMED GLASS WITH POTLIGHT
Line23209	Note:
21Feb17 / 26Oct17	

Inv.1,200	1 - KITCHEN: ROUGH-IN FOR RAINSHOWER HEAD- DOES NOT INCLUDE SHOWER HEAD AND DIVERTER AND MUST BE PURCHASED THROUGH GOLDPARK
Line24535	Note:
21Feb17 / 26Oct17	

GLASS AND MIRROR

Inv.1,200	1 - TWIN BATH- SHOWER IN LIEU OF TUB – FRAMED GLASS WITH POTLIGHT
Line19521	Note:
21Feb17 / 26Oct17	

GRANITE MARBLE QUARTZ

Inv.1,200	1 - MASTER ENSUITE: UPGRADE 3 CAESAR STONE EDGE: FE-20
Line19899	Note:
21Feb17 / 26Oct17	

INTERIOR TRIM AND DOORS

Inv.1,200	4 - MAIN FLOOR: EXTENDED HEIGHT ARCHWAY (PRICE PER DOORWAY) - INCLUDE FRAMING NOTE
Line17826	Note:
21Feb17 / 26Oct17	

KITCHEN AND BATH CABINetry

Inv.1,200	1 - TWIN BATH- SHOWER IN LIEU OF TUB – FRAMED GLASS WITH POTLIGHT
Line23212	Note:
21Feb17 / 26Oct17	

MISC.

Inv.1,200	1 - Purchaser has attended a Structural & Colour appointment at the Decor Centre & has DECLINED any additional upgrades and accepts and acknowledges that there will be no further structural changes/additions/deletions to be made upon signing.
Line19651	Note:
21Feb17 / 26Oct17	

Inv.1,200	1 - Purchasers are aware & accepts that ANY changes made to upgrades after signing this Purchasers Extra Form are subject to a minimum administration fee of \$500. PLUS a 10% holdback fee.
Line19652	Note:
21Feb17 / 26Oct17	

Inv.1,200	1 - BONUS PACKAGE: \$20,000.00 (INCLUDING TAXES) WORTH OF UPGRADES FROM GOLD PARK HOMES DÉCOR CENTRE IS BEING APPLIED TOWARD THE STRUCTURAL APPOINTMENT. PURCHASER HAS A REMAINING AMOUNT OF \$00 (INCLUDING TAXES) TO BE USED TOWARD THE COLOUR APPOINTMENT.
Line19653	Note:
21Feb17 / 26Oct17	

Kleinburg Glen - 14 - 2 - 38-1 Elev.B HAMPTON

Inv.1,200	1 - Purchaser request that all upgrades from this purchaser's extras form to be added to the purchase price. Purchaser is aware that upgrades will be processed only after the builder receives approval letter from the bank.
Line19654	Note:
21Feb17 / 26Oct17	

Inv.1,656	1 - RE-OPENING FEE WAIVED AS PER MICHAEL
Line25021	Note:
27Nov17 / 6Dec17	

PLUMBING

Inv.1,200	1 - KITCHEN: ROUGH-IN FOR RAINSHOWER HEAD- DOES NOT INCLUDE SHOWER HEAD AND DIVERTER AND MUST BE PURCHASED THROUGH GOLDPARK
Line19505	Note:
21Feb17 / 26Oct17	

Inv.1,200	1 - UPGRADE TO FREE STANDING TUB - UPG1 ONLY
Line19504	Note:
21Feb17 / 26Oct17	

Inv.1,200	1 - TWIN BATH- SHOWER IN LIEU OF TUB – FRAMED GLASS WITH POTLIGHT
Line23210	Note:
21Feb17 / 26Oct17	

PLUMBING FIXTURES

Inv.1,200	1 - MASTER ENSUITE: Shower Faucet Arzo
Line19507	Note: Arzo TempAssure 3 Function Shower System #T17T267-50570-T11867-R10000-UNBXFH (Chrome) + 6inch straight arm from ceiling for rain shower
21Feb17 / 26Oct17	

Inv.1,200	2 - MASTER ENSUITE x2 - UPG Vanity Sinks Contrac Camden Undermount #4210CHY
Line19509	Note:
21Feb17 / 26Oct17	

Inv.1,200	3 - MASTER ENSUITE x2 / POWDER ROOM: Vanity Faucet Arzo single lever #586LF-MPU
Line19506	Note: See spec sheet attached
21Feb17 / 26Oct17	

Inv.1,200	1 - MASTER ENSUITE Tub Faucet: UPG Arzo 3 Piece Roman Tub (chrome) #T2786/R2709
Line19508	Note: See spec sheet attached
21Feb17 / 26Oct17	

Inv.1,200	1 - POWDER ROOM: Delete Pedestal and add Contrac Marleau 24" WH Vanity Combo High Gloss Grey Finish with White Vanity Top MAHG2318
Line19512	Note:
21Feb17 / 26Oct17	

STAIRS AND RAILINGS

Inv.1,200	1 - STAIN STAIRS & HANDRAIL: UPG to Vintage 'Pewter'
Line19522	Note:
21Feb17 / 26Oct17	

Inv.1,200	1 - STAIRS & HANDRAIL & PICKETS; UPG to Euroline 1 with V-Groove handrail
Line19523	Note:
21Feb17 / 26Oct17	

*** NOTE: This is not an approved document. Document must be locked ***

Scheduled Closing Date:

Purchaser: Teresa Francavilla

Property: 14

Telephone Res. / Bus: (416) 806-1965

Project: Kleinburg Glen - Phase 2

Decor Advisor: Laura Lofaro

Model and Elevation: 38-1 Elev.B HAMPTON

Layout Changes: Yes No Sketch Attached: Yes No Exterior Colour Scheme:

1. Cabinetry

	Style and Colour	Counter	Hardware
Kitchen / Breakfast	Varese PVC WhtCrystal	Granite Pol. Grigio Sardo STD FE20 E	CS1-23
Laundry Room	N/A		
Powder Room	N/A		
Master Ensuite Bathroom	Varese PVC WhtCrystal	*Caeastone Stone Grey 4030 Std FE20	CS1-23
Second Ensuite Bathroom (If Applicable)	Varese PVC WhtCrystal	P-Lam # P-344-LM 'Inukshuk Grey'	cs1-23
Twin Bath	Varese PVC WhtCrystal	P-Lam # P-344-LM 'Inukshuk Grey'	cs1-23

Comment

2. Floor Tile

	Selection
Entrance Vestibule	13x13" Carrara 'White/grey'
Main Hall	n/a
Kitchen / Breakfast	13x13" Carrara 'White/grey'
Laundry Room	13x13" Carrara 'White/grey'
Powder Room	13x13" Carrara 'White/grey'
Master Ensuite Bathroom	*24x24 Himalaya Series Grey upg 5
Second Ensuite Bathroom (If Applicable)	*12x24 Globe Pol. Charcoal upg 4
Lower Landing (If Applicable)	
Twin Bath	*12x24 Globe Pol. Charcoal upg 4

Comment

Please completely tile below cabinets - vanities will be replaced with wall-hung vanities after closing.

3. Wall Tile

	Selection	Listello/Inserts	Describe
Master Ensuite Bathroom		<input type="radio"/> Yes <input checked="" type="radio"/> No	
Tub Deck	n/a	<input type="radio"/> Yes <input checked="" type="radio"/> No	
Shower Stall	4x16 CDC Sterling Grey Bright	<input type="radio"/> Yes <input checked="" type="radio"/> No	
Bathroom Walls	N/A	<input type="radio"/> Yes <input checked="" type="radio"/> No	
Second Ensuite Bathroom (If Applicable)	*Queen Series Tend.Grey upg 4	<input type="radio"/> Yes <input checked="" type="radio"/> No	
Twin Bath (3/4)	*Queen Series Tend.Grey upg 4	<input type="radio"/> Yes <input checked="" type="radio"/> No	
Kitchen Backsplash	<input type="radio"/> Yes <input checked="" type="radio"/> No	Backsplash Behind Fridge	<input type="text"/>

Comment

*Master Ensuite: Shower Stall 4x16 CDC Sterling Grey Bright
 *Ensuite 2 / Twin Bath Ensuite Shower Wall Tile: Queen Series Tender Grey 1.8"x2.3"

Scheduled Closing Date:

Purchaser: Teresa Francavilla
Telephone Res. / Bus: (416) 806-1965
Decor Advisor: Laura Lofaro

Property: 14
Project: Kleinburg Glen - Phase 2
Model and Elevation: 38-1 Elev.B HAMPTON

4. Plumbing Fixtures

<input type="checkbox"/>	Second Ensuite	<input type="checkbox"/>	Powder Room	<input type="checkbox"/>
Master Ensuite Bathroom	<input type="checkbox"/>	Other Room - Specify	<input type="checkbox"/>	Other Washroom
		<input type="checkbox"/>		

Comment

*See Additional Comments below

5. Hardwood Flooring

	Type and Stain		Type and Stain
Main Hall	Preverco Red Oak 'INOX'	Upper Landing	N/A
Kitchen / Breakfast	N/A	Upper Hall	N/A
Living Room	N/A	Master Bedroom	N/A
Dining Room	Preverco Red Oak 'INOX'	Bedroom #2	N/A
Family Room	Preverco Red Oak 'INOX'	Bedroom #3	N/A
Den/Library	N/A	Bedroom #4	N/A
Entrance Vestibule	N/A	Bedroom #5	N/A
Lower Landing (If Applicable)	N/A	Other Room - Specify	N/A
		<input type="checkbox"/>	<input type="checkbox"/>

Comment

6. Carpeting

	Upgrade	Description
Ground Floor	<input type="checkbox"/>	N/A
Second Floor	<input type="checkbox"/>	T-04
<input type="checkbox"/>	<input type="checkbox"/>	N/A

Upgrade Underpad	Type	Area
	N/A	<input type="checkbox"/>
Carpet on Stairs	Capped	Runner - *Upgrade
	N/A	<input type="checkbox"/>

Comment

7. Fireplace

	Living Room			Family Room			Other Room - Specify Great Room		
	Purchased	As Per Plan	N/A	Purchased	As Per Plan	N/A	Purchased	As Per Plan	N/A
Fireplace Type	<input type="radio"/>	<input type="radio"/>	<input checked="" type="radio"/>	<input type="radio"/>	<input type="radio"/>	<input checked="" type="radio"/>	<input type="radio"/>	<input checked="" type="radio"/>	<input type="radio"/>
Mantle Type	<input type="checkbox"/>						Gas		
Colour / Stain	<input type="checkbox"/>						STD Cast Stone		
Surround	<input type="checkbox"/>						STD		
Hearth	<input type="checkbox"/>						STD		
Hearth	<input type="checkbox"/>						*Declined Hearth		

Comment



Scheduled Closing Date:

Purchaser: Teresa Francavilla

Property: 14

Telephone Res. / Bus: (416) 806-1965

Project: Kleinburg Glen - Phase 2

Decor Advisor: Laura Lofaro

Model and Elevation: 38-1 Elev.B HAMPTON

8. Trim Carpentry

Interior Doors Front Door Glass Inserts Door Handles

Interior Trim

Comment

9. Plaster Mouldings and Medallions

Standard Throughout Yes No

Entrance Vestibule Kitchen/Breakfast

Main Hall Den/Library

Living Room Lower Landing

Dining Room Other Room - Specify

Family Room

Comment

10. Railings and Spindles

Railing Package

Railing Colour

Spindle Colour

Stringer / Riser

Treads

Comment

Oak Stairs Yes No

Stairs will not match hardwood floors

11. Wall Paint / Ceilings

Throughout Finished Areas

Thru-Out

Trim Paint

Smooth Ceilings

Ground Floor

Second Floor

Note

Comment

Scheduled Closing Date:

Purchaser: Teresa Francavilla

Property: 14

Telephone Res. / Bus: (416) 806-1965

Project: Kleinburg Glen - Phase 2

Decor Advisor: Laura Lofaro

Model and Elevation: 38-1 Elev.B HAMPTON

12. Electrical

Hood Fan White Stainless

Above Kitchen Cabinet Light Yes No

Below Kitchen Cabinet Light Yes No

Standard Appliances

Over The Range Microwave

Chimney Style Fan

Comment

SS Hood Fan

13. Heating and Air Conditioning

Air Conditioning

Gas Provisions Stove

Gas Provisions Dryer

Gas Provisions Barbecue

Comment

Standard Gas BBQ Line

14. Additional Comments

Powder Room: Delete STD Pedestal and UPG to Contrac Marleau 24" WH Vanity Combo - High Gloss Grey Finnish with White Vanity Top. MAHG2318

Master Ensuite Shower Faucet - Arzo TempAssure 3 Function Shower System #T17T267-50570-T11867-R10000-UNBXFH (Chrome) + 6inch straight arm from ceiling for rain shower

MASTER ENSUITE Tub Faucet: UPG Arzo 3 Piece Roman Tub (chrome) #T2786/R2709

MASTER ENSUITE x2 - UPG Vanity Sinks Contrac Camden Undermount #4210CHY

See invoice and spec sheet for more details

15. Disclaimers and Notes

1) Colours of all materials are as close as possible to builder's selection, but not necessarily identical due to variances in manufacturing.

2) Any extras listed above are null and void unless accompanied by a separate invoice/amendment. Said invoice must be paid in full.

3) The Purchaser acknowledges that after Interior Colour Selection form is signed and dated, no further changes will be permitted other than re-selection due to unavailability. _____ Purchaser's Initials

4) The Purchaser acknowledges reading and accepting the "Gold Park Homes Decor Centre Disclaimers" form. This document contains other miscellaneous disclaimers.

This Interior Colour Selection is final and approved by:

Signature:  Date: _____

Gold Park Homes Décor

GOLDPARK
WORTH MORE™

Centre Disclaimers

Through years of doing business, we at Gold Park Homes have encountered issues beyond our control. The following disclaimers apply to all instances of Purchaser's Extras forms and all Interior Colour Scheme forms.

FIREPLACES

Fireplace Marble: Due to the many variables that can affect the pattern and/or design, frequently the marble installed on the fireplace will not be identical to the samples. We will make every attempt to come as close to the samples as possible, but cannot be responsible for results which differ from the samples.

CERAMIC FLOOR TILE

Many variables including variegation can affect tile colour, pattern and/or design which mean installed tiles may not be identical to the samples. We will make every attempt to come as close as possible, but cannot be responsible for results which differ from the samples.

HARDWOOD FLOORING

The purchaser is advised that cupping and shrinkage are characteristics of hardwood flooring normally appearing after installation, especially when humidity levels are not regulated, and no warranty is provided by the flooring supplier with respect to such cupping and shrinkage. Furthermore, hardwood floors may also heave and warp when located at or close to entrance points of the home, where rain could make its way to the flooring. The vendor agrees to install any hardwood flooring ordered by the purchaser in a good and workmanlike manner, but shall not be responsible for, and is hereby released by the purchaser from responsibility and liability for cupping, shrinkage, heaving and warping of hardwood flooring in the above mentioned circumstances.

STAIRCASE VS FLOORING

WOOD SPECIES DIFFERENCE

The purchaser is aware and therefore accepts and acknowledges that the wood species of the staircase and flooring chosen do not match. This difference might result in an undesirable colour variance

The purchaser is aware and therefore accepts and acknowledges that though the flooring is of the same species as the staircase the difference in product finishing may result in a stain colour variance.

The purchaser agrees that the vendor is to be exempt from any and all claims by the purchaser regarding this colour variance.

RAILINGS

All railings, pickets, posts, nosing's and stairs come from solid wood and veneered wood materials sourced from multiple locations and sources. As such there will be variations in grains and shades between the various natural components beyond our control. Due to this variance in material, all components will stain with colour or natural finish differently.

Iron pickets are wrought in nature and depending on the manufacturing process will have differences from picket to picket which is normal. Also the finish of the iron pickets is of a powder coated nature. This process can produce minor colour variations or tones. Furthermore, the assembly of the metal pickets can develop a natural rattle over time from vibration in the railing. Minor rattling is normal and is a part of the wrought iron picket assembly.

HOUSE EXTERIORS

Variations in subcontractors across different sites and varying site conditions may result in house exteriors that differ from the artist renderings. We cannot be responsible for results which differ from the artists renderings of elevations.

PLASTER MOULDINGS AND MEDALLIONS

Plaster mouldings will not be installed in open to above areas or areas with 2 storey elements.

STAIN COLOURS

Due to the many variables that can affect the outcome of a stain colour on wood, staircases, railings, and fireplaces, the colour may not be identical to samples. Factors such as density, age, humidity, air temperature, and the uniqueness of each piece of wood can result in wide variations in darkness or lightness. We will make every attempt to come as close to the sample as possible, but cannot be responsible for results which differ from the samples.

Stain on pre-finished hardwood floors will not be an exact match to the stain colours available on stairs, pickets and rails. The purchaser is responsible for choosing the stain on these areas to their satisfaction.

IN-WALL CONDUIT FOR AUDIO/VIDEO CABLES

It is important to note that due to the variation in framing requirements in different parts of your home, conduit lengths and routing can vary. In virtually all instances of ground floor installation (I.e. above a fireplace), conduit will first travel down into the basement below the floor joists, over to the termination point and back up into the main floor. As a result, it is best to measure the length of the conduit after occupancy with a "pull wire" before

1662-14

WAR. 23, 2017

purchasing your cables. For above-fireplace installations, the conduit wall plate will be installed approximately 10" above the Fireplace Mantle, unless otherwise specified in the Construction Summary.

APPLIANCE SPECIFICATIONS

All appliance openings are set to builder's standard openings. Please advise Décor Centre at time of your structural appointment if custom sizing of cabinets is required for any built-in appliances. The purchaser is responsible for costs and fees associated with changes to pre-manufactured kitchens made subsequent to colour appointments.

Purchaser accepts & acknowledges that in order to accommodate upgraded appliances, all appliance specifications should be provided at the time of their structural appointment, should this not occur they must be provided to the Décor Center within one (1) week of completion of structural chart. Failure to do so may result in the need to re-open your structural file should changes be required. As a result we may be forced to extend the closing of your transaction. Due to failure to complete the above-mentioned selections and at no fault of our own, we reserve our right to hold you responsible for this delayed closing, including charging extra administration cost and interest on the balance due on closing.

Purchasers Accept Standard Appliance Openings (unless otherwise specified):

Fridge - 37-1/2"W x 73-1/2" High Approx.

Range - 30-1/2"D x 31-1/2"W Approx.

Dishwasher - 24" W Approx.

DELETION OF HOODFAN & CABINETS ABOVE STOVE:

The purchasers are aware that in requesting NOT TO INSTALL builder's standard hood fan and standard cabinets above stove they will receive NO STANDARD HOOD FAN and NO CREDIT. Purchasers are installing their own hood fan after closing and accept that it may waive any warranty associated with such a change.

Purchasers accept and acknowledge that the exhaust fan duct hole may be off-centered with the stove in the kitchen due to purchasers installing their own hood fan after closing. The vendor is exempt from adjusting such openings for the purchasers range hood.

ELECTRICAL FOR APPLIANCES

Pricing is subject to change based on the appliance specifications provided. Purchasers should provide proper appliance specifications and cut-out sheets in order for Gold Park to price extras accordingly.

KITCHEN CABINETS

The kitchen you order/purchase will undoubtedly contain slight colour variations. The degree of these variations is virtually impossible to determine before the kitchen is installed in its intended location. The amount of and type of lighting will also affect various highlights in the finish. Note: No two pieces of wood are identical. Variations in colour tone and grain patterns make a perfect colour match virtually impossible. It is generally agreed that these variations add to the natural beauty of a wood kitchen.

STAIN

Charcoal is a spray stain applied to Oak and Maple products with several characteristics that are important to be aware of when purchasing this product.

1. Shadow lines may be visible at the interior profile edges of a door or drawer front. If movement occurs shadow lines may increase or decrease, depending on the style and/or size of a door or drawer front.
2. Variation and unevenness may be visible in the finish.
3. Hairline cracks at the joints are created over time due to the nature of natural wood, caused by usage, humidity**, or dryness. They tend to be more visible to darker stains, than lighter wood stains.

** Relative humidity is recommended to be between 45% and 55%. Please refer to Cortina Kitchens "Cleaning, Care, Maintenance, & Warranty Information" guide.

Please be advised that Cortina Kitchens will not replace doors and/or parts that exhibit the above characteristics associated with this finish. These characteristics are not avoidable and are a result of the natural characteristics of wood and wood veneer, and the characteristics of darker stains on wood. The Charcoal stain is not available on doors in Group IV, Group IVA, Group V and Group VA.

Cortina Kitchens offers a wide variety of finishes, applied to oak and maple products. The subject finishes include the spray stains Cocoa, Espresso, Graphite as well as wiping stain Ebony.

Due to the very dark stains applied on natural maple and oak doors and joints, several characteristics are important to be noted when purchasing these products.

1. Shadow lines may be visible at the interior profile edges of a door or drawer front. If movement occurs shadow lines may increase or decrease, depending on the style and/or size of a door or drawer front.
2. Variation and unevenness may be visible in the finish.
3. Hairline cracks at the joints are created over time due to the nature of natural wood, caused by usage, humidity, or dryness. They tend to be more visible to darker stains, than lighter wood stains.

Please be advised that Cortina Kitchens will not replace doors nor parts that exhibit the above characteristics associated with this finish. These characteristics are not avoidable and are a result of the natural characteristics of wood and wood veneer, and the characteristics of darker stains on wood.

K62-14

MAR 23, 2017

CABINERY DOOR HARDWARE

Cortina Kitchens' cabinetry doors and drawer fronts will be drilled to accept a standard knob or handle selected from Cortina's hardware boards. This drilling comes standard with the order, and is done **ONLY** in our shop, not on the job site.

For those not wanting Cortina's hardware drilling, the following applies:

No holes to be drilled on the doors and drawer fronts should be specified in writing on the colour chart and the P.O. If while in production, Cortina Kitchens misses this request, Cortina Kitchens and the Builder will not be held responsible to replace any or all doors and drawer fronts affected, and the customer agrees to accept the product as is. No hardware will be supplied or credited by Cortina Kitchens with this request. No charge will apply for this request.

PVC DOORS

All cabinets with PVC (Thermofoil) Doors come with melamine gables, panels and kick. The doors, crown moulding and light valance are PVC wrapped. Open shelves incorporated in design will only be available with melamine interiors. There will be variations in colour shades between the PVC parts (doors, crown and Light valance) and the melamine parts (open shelves, Gables, Panels and Kick) due to the difference in material.

Furring Panel with crown moulding to the ceiling is not available on all PVC door styles due to subtle variations in colour shades between the PVC parts (moulding) and the melamine parts (furring panel) due to the difference in material. Grain directions in wood grain pattern melamine, vary between the furring panel, crown moulding (horizontal) and the PVC doors (vertical).

GRANITE, MARBLE ENGINEERED SURFACES WAIVER

Granite and marble are naturally occurring products, and due to the many variables that can affect the pattern, colour and/or design and "pitting" of natural products slabs installed will not be identical to the samples displayed. We will make every attempt to come as close to the samples as possible, but cannot be responsible for results which differ from the samples. Every effort is made to provide granite counter tops as close as possible but the vendor is not responsible for results which differ from the sample displayed. All countertop surfaces may have seems & product pattern & shade can change in areas containing seems.

RESELECTIONS

It is not uncommon for flooring, such as tile, to become discontinued prior to its installation. Therefore it may be necessary to make a reselection of certain materials sometime during the build process. We cannot assure you that another choice approximating your selection will be available.

PLANS

Plans are subject to change without notice. Actual usable floor space may vary from the stated floor area. Layout for kitchen, furnace, HWT and laundry tub may vary from plan. Vertical and horizontal bulkhead, which are not shown on plan, may be required for plumbing and heating runs. E.& O.E.

PLEASE NOTE:

In the event the work on the house has progressed beyond the point where the items covered by these invoices cannot be installed without entailing any unusual expense, then this order is to be cancelled and any deposit paid in connection with the same is to be refunded to the purchaser.

The vendor will undertake to incorporate the work covered by the sales extra in the construction of the house but will not be liable to the purchaser in any way, if for any reason the work covered by the extra is not carried out. In that event, any monies paid in connection with the same shall be returned to the purchaser.

It is understood and agreed that if for any reason whatsoever the transaction of Purchase and Sale is not completed, the total cost of extras ordered are not refundable to the Purchaser(s).

Extras or changes will not be processed unless signed by the Vendor.

These extras may not be amended without the written consent of Gold Park Homes.

The purchaser(s) and the builder acknowledge and agree that this "Purchaser's Extra" form shall not be deemed to be part of the agreement of purchase and sale entered into between them, nor an addendum thereto.

No postdated cheques will be accepted.

No estimates or orders will be accepted once construction has commenced.

Should a refund be requested on any extras purchased, an 80% reimbursement of the purchase price will be given. (a \$50.00 minimum charge and a maximum \$250.00 charge will apply)

Estimates will only be considered when resubmitted on a signed Purchaser Extras form, accompanied by payment in full.

All prices are estimates only and may be subject to change. Should a change in price occur Gold Park Homes reserves the right to request from the purchaser an adjustment of the price or a refund limited to that item.

Purchasers are aware & accept that ANY changes made to upgrades after signing the Purchasers Extra Form are subject to a minimum administration fee of \$500. PLUS a 10% holdback fee.

Purchasers are aware that any request to add a percentage of upgrades from the purchaser's extras form will be processed only after the builder receives approval letter from the bank.

662-14

MAR. 23, 2017

Please be advised that your failure to finalize your structural or colour selections may result in a delay in construction of your dwelling and we may have to extend closing of your transaction. Due to failure to complete the above-mentioned selections and at no fault of us, we reserve our right to hold you responsible for a delayed closing, including charging extra administration cost and interest on the balance due on closing.

Purchaser has attended a Colour appointment at the Decor Centre & has DECLINED any additional upgrades and accepts and acknowledges that there will be no further structural changes/additions/deletions to be made upon signing.

I hereby acknowledge reading and understanding the above copy and will not hold Gold Park Homes responsible for any issues in relation to above.

Purchasers Signatures

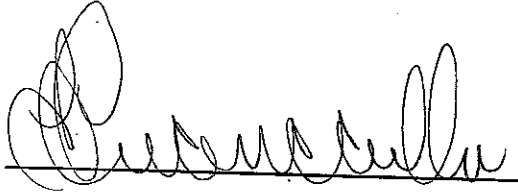

Date

Mar 24-17

1462-14

MAR 23, 2017

Elevation A - 2,388 sq.ft.

Elevation B - 2,375 sq.ft.

REVISED
NOV. 27 2017
KG2-14
NOV 27 2017

FUTURE 24" DEEP CABINETS

- OVEN → 220V
- LOCATE 40" from wall 22" A.F.F.
- FRIDGE
- LOCATE 74" from wall (STD HEIGHT)

RELOCATE SID (LT. LIGHT ABOVE ISLAND, ADD EXT. CAPPED. IN LINE. (SAME SWITCH))
REPAIR ISLAND

MAKE STD BREAKFAST CEILING LIGHT IN LINE WITH ISLAND CAPPED LIGHTING.

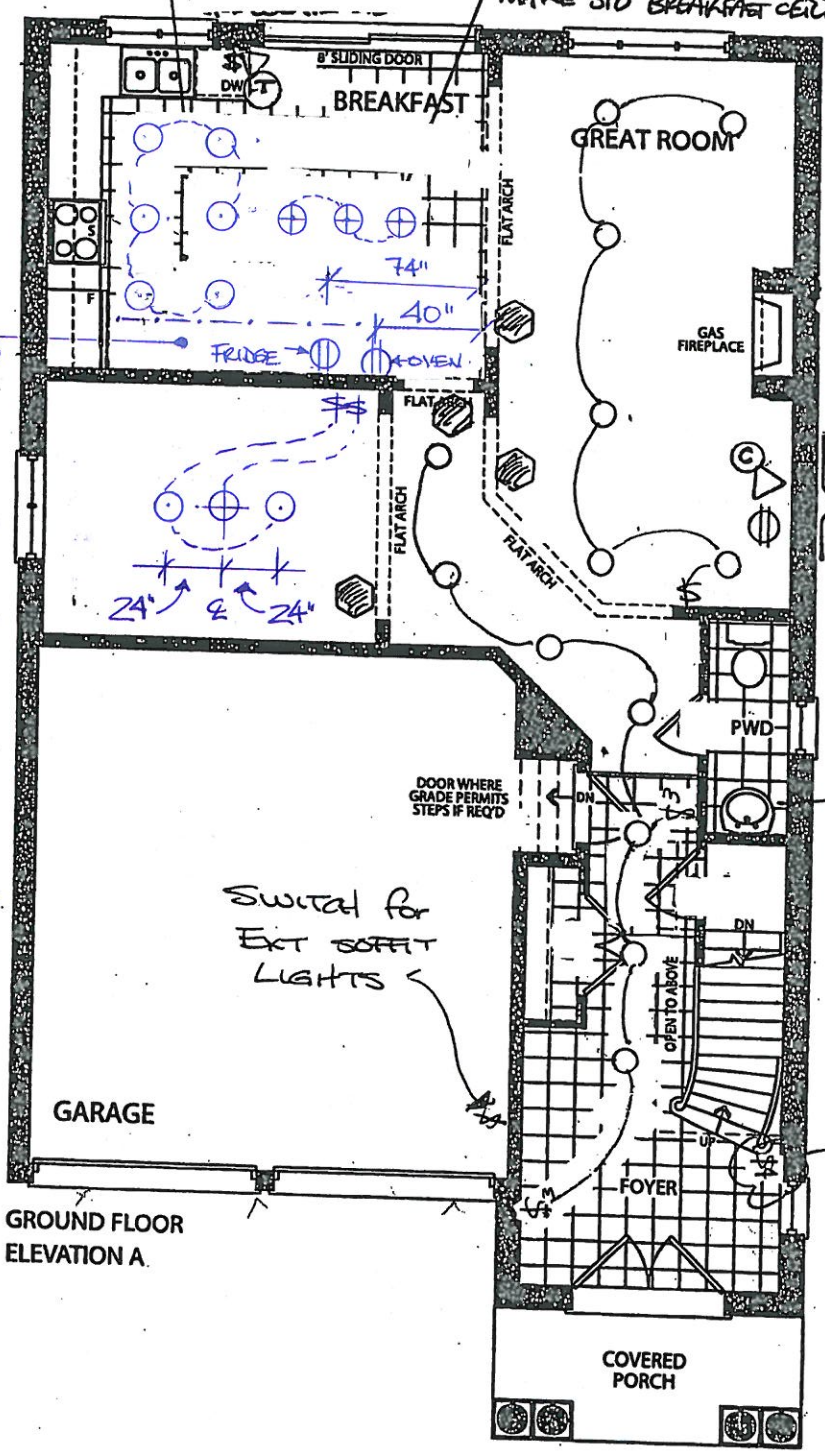

CABLE + 110V RECEPTACLE @ 55" AFF

24" WALL HUNG VANITY

4WAY SWITCH FOR 2ND FLOOR POT LIGHTS

GROUND FLOOR ELEVATION A.

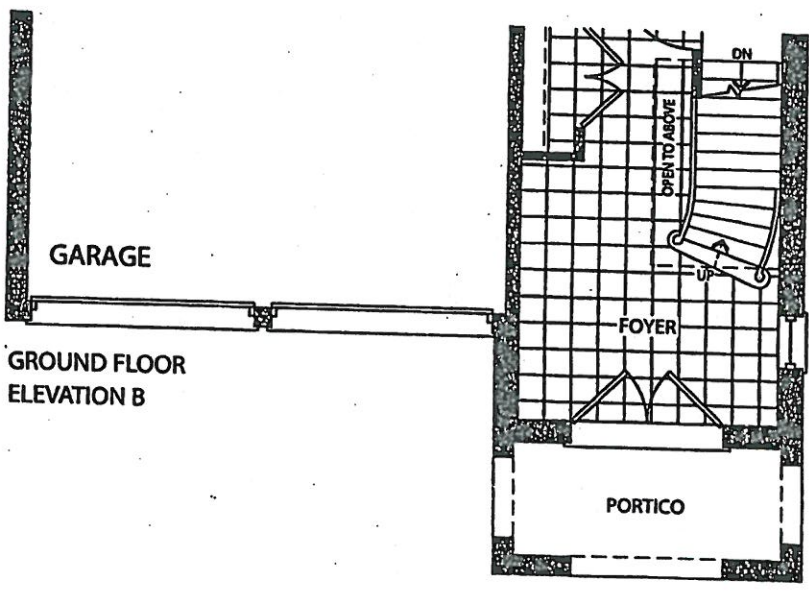

GROUND FLOOR ELEVATION B

REVISED
MARCH 27 2017

LEGEND

- \$ - SWITCH
- T - TELEPHONE
- C - CABLE
- ⊕ - CEILING CAPP.
- ⊘ - RECEPTACLE
- - POT LIGHTS
- ⊞ - 96" ARCHWAY

KG2-14
STRUCTURAL
&
CONCRETE

MARCH 23 2017

Prices, figures, illustrations, sizes, features and finishes are subject to change without notice. E.&O.E. Areas and dimensions are approximate and actual usable floor space may vary from the stated area. Layout may be reverse of the unit purchased. E. & O.E.

Elevation A • 2,388 sq.ft.

Elevation B • 2,375 sq.ft.

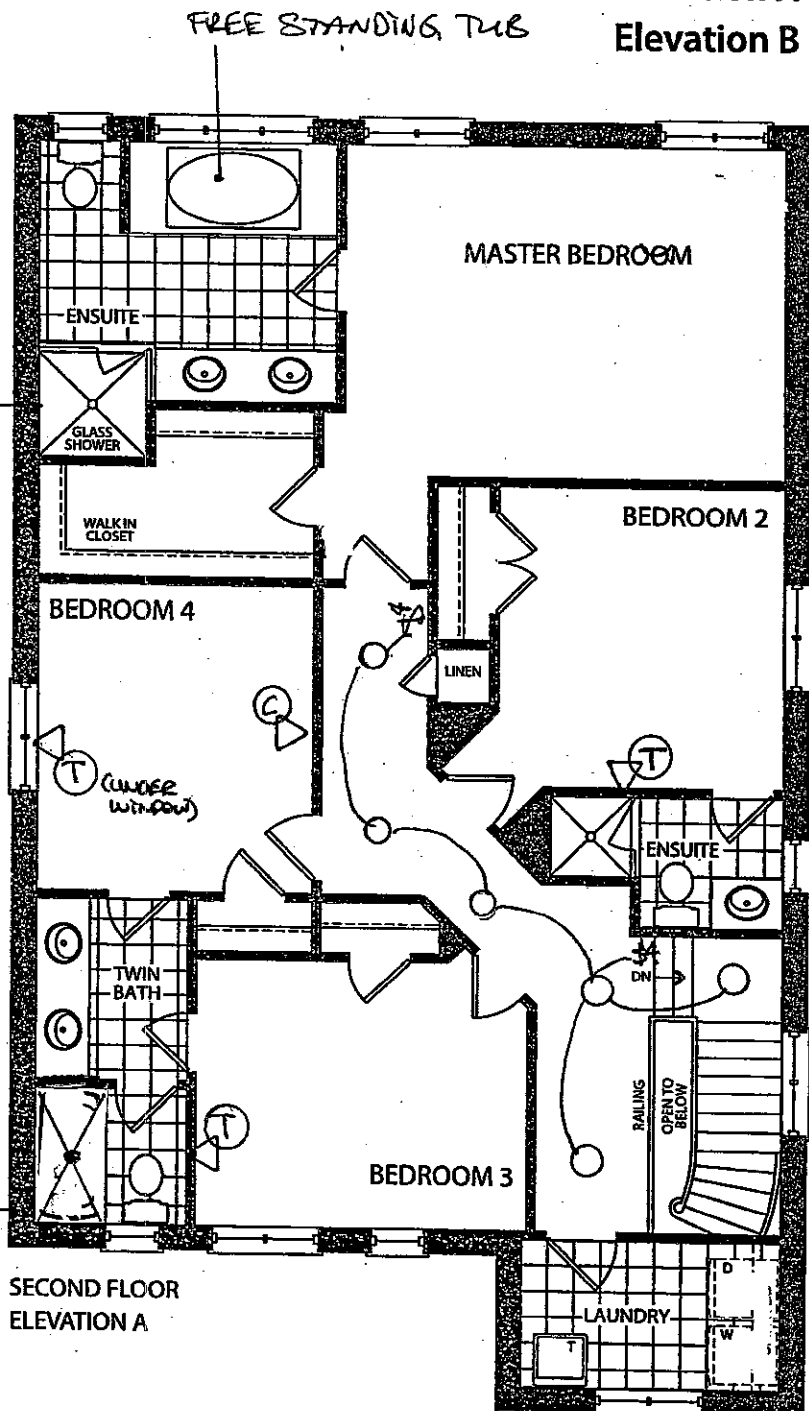

FRAMELESS SHOWER.

TUB TO SHOWER
CONVERSION
FRAMED
GLASS

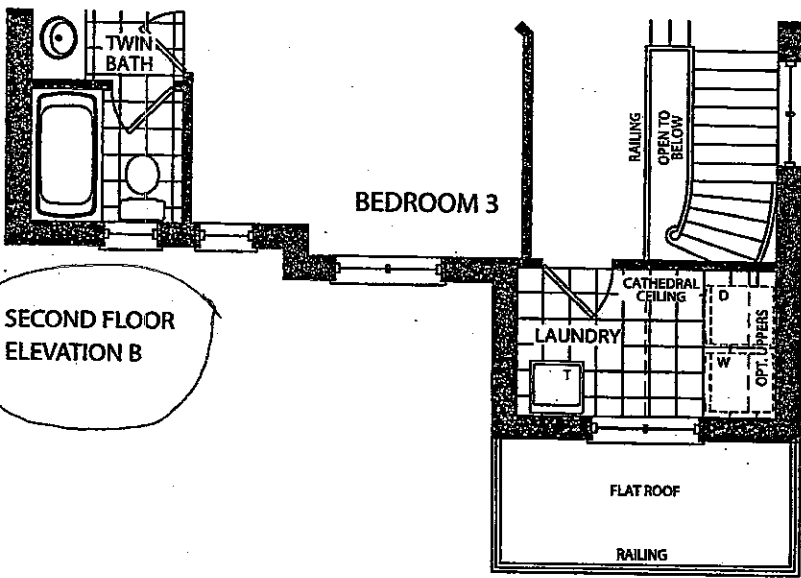

REVISED MAR 27 2017

KG2-14
SILVER
+
COLOURS

MAR 23, 2017

Prices, figures, illustrations, sizes, features and finishes are subject to change without notice. E.&O.E. Areas and dimensions are approximate and actual usable floor space may vary from the stated area. Layout may be reverse of the unit purchased. E. & O.E.

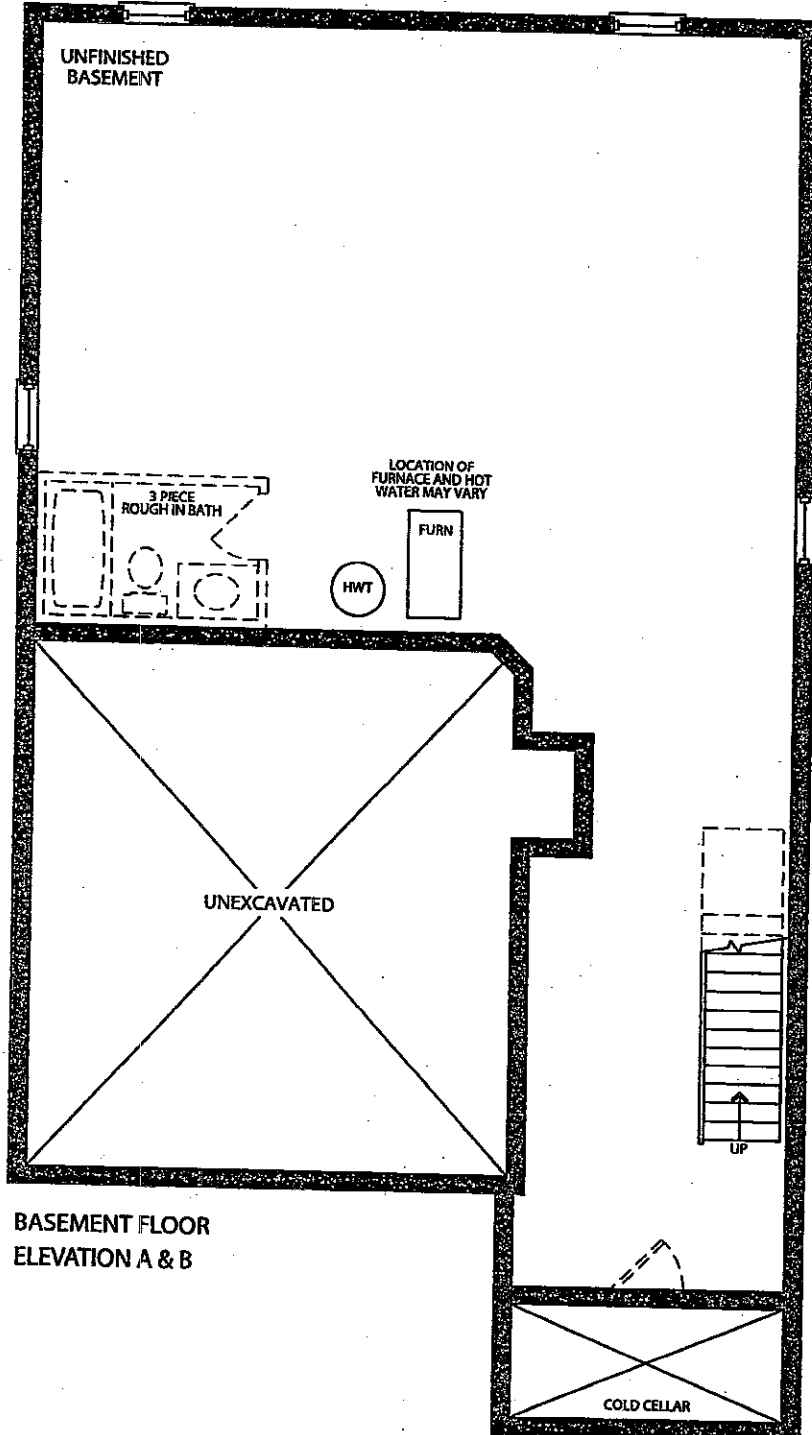

BASEMENT FLOOR
ELEVATION A & B

Revised March
27, 2017

KG2-14
STRUCTURAL
&
COLOURS

[Signature]

MARCH 23, 2017

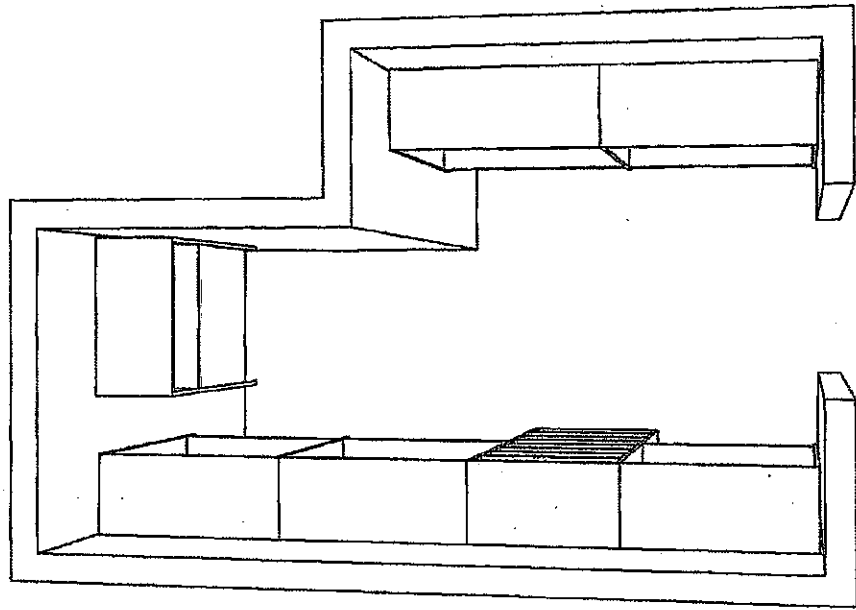

162-14



MARCH 23, 2017

The Home Organizer <YOUR ADDRESS> <YOUR CITY AND STATE> Phone: <YOUR PHONE NUMBER> Fax: <YOUR FAX NUMBER>	GPH MODEL 38-1	Perspective
	GPH MODEL 38 -1 Room 1	Current Date: Feb 07, 2017 Scale: NTS

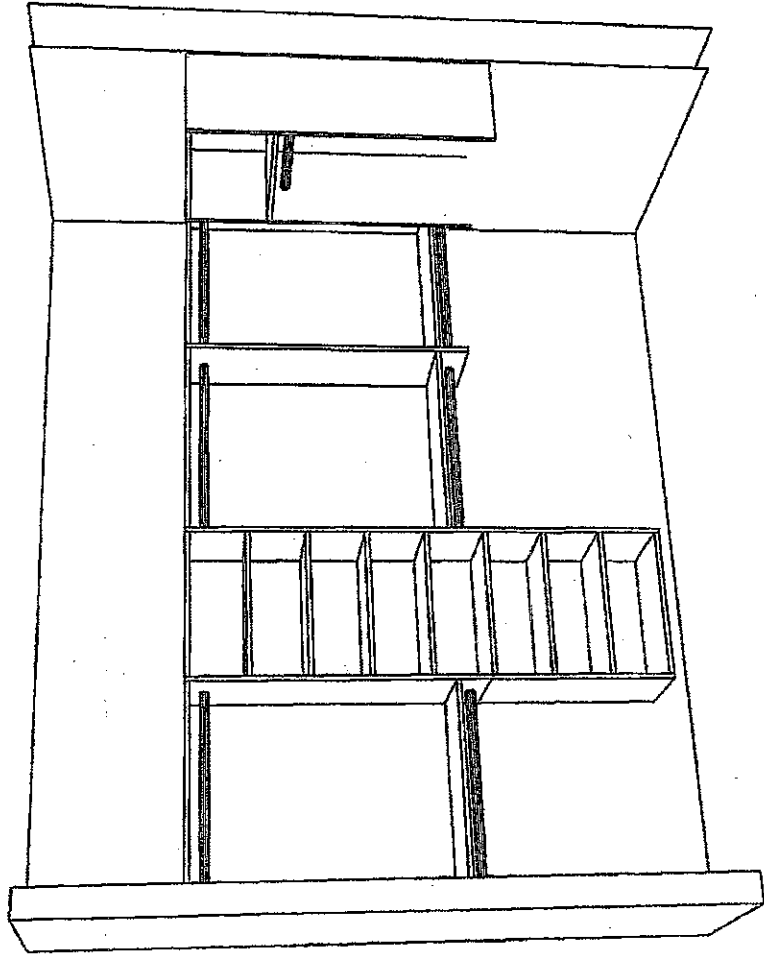

K62-14

MAR 23, 2017

The Home Organizer

<YOUR ADDRESS>

<YOUR CITY AND STATE>

Phone: <YOUR PHONE NUMBER> Fax: <YOUR FAX NUMBER>

GPH MODEL 38-1

GPH MODEL 38 -1 Room 1

Perspective

Current Date: Feb 07, 2017

Scale: NTS

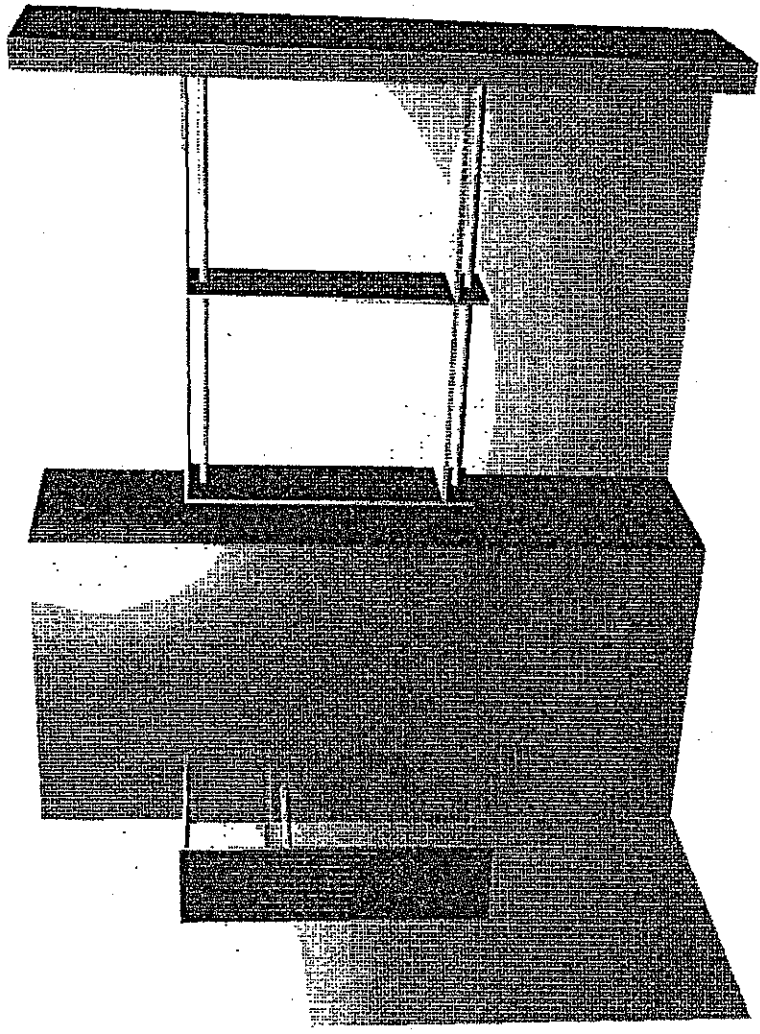

The Home Organizer <YOUR ADDRESS> <YOUR CITY AND STATE> Phone: <YOUR PHONE NUMBER> Fax: <YOUR FAX NUMBER>	GPH MODEL 38-1	Perspective
	GPH MODEL 38 -1 Room 1	Current Date: Feb 07, 2017
		Scale: NTS

MI-2591
[Signature]

MARCH 23, 2017

CORTINA

70 Regina Road, Woodbridge, Ontario L4L 8L6
Tel: 905-284-8484 Fax: 905-284-0884
www.CortinaKitchens.com

QUOTATION

Date: 28/06/16

Trade Name: Gold Park Homes	Site location:	Model: 38-1
Address:	Project: Kleinburg Glen	Phase:

This layout has been explained to the purchaser by Cortina Kitchens Inc. and is understood by the purchaser.

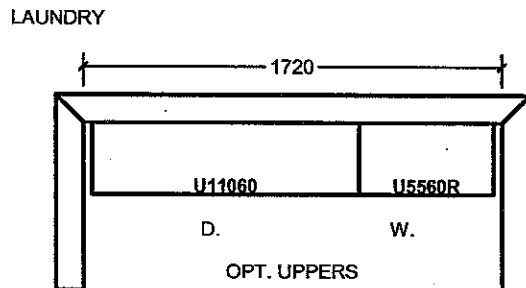
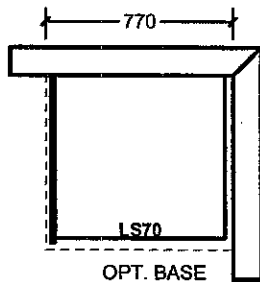
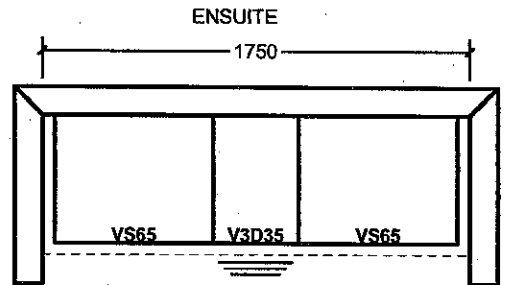
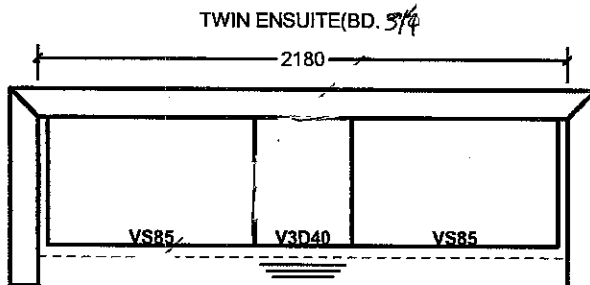
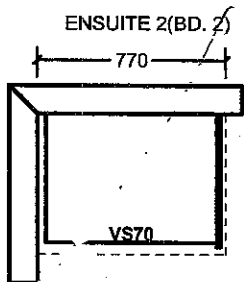
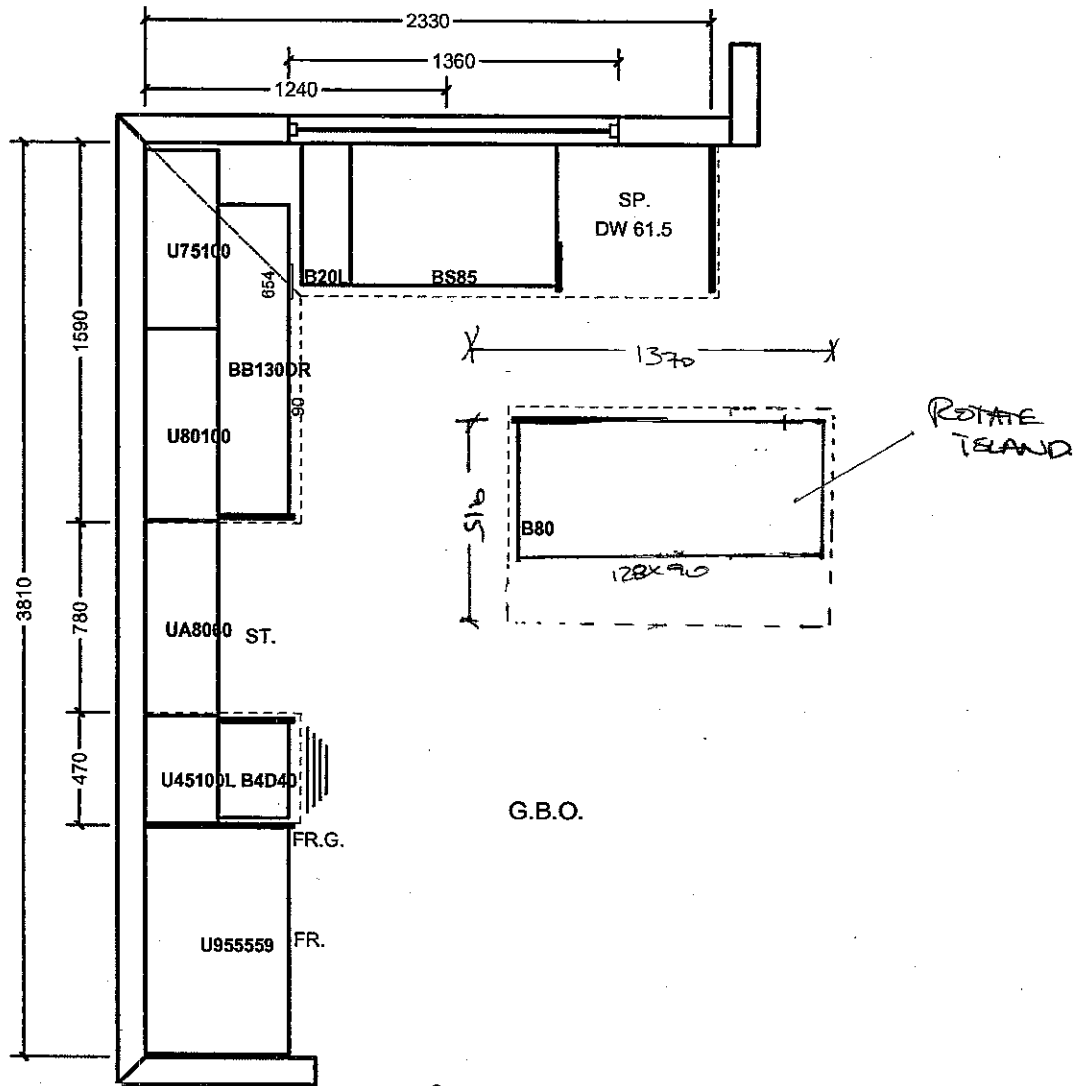

All prices subject to confirmation from head office.
This quotation is subject to the terms & conditions set out

ACCEPTED DATE: MARCH 23, 2017

All agreements are contingent upon strikes, accidents, and delays beyond our control.
Please provide our installer with template for sinkholes or \$150.00 will be charged for callback.

K62-14

Item A. Wood grain and colour are characteristics of the product. We cannot guarantee that such grain and colour will always match.
Item B. Cortina Kitchens Inc. reserves the right to alter dimensions and make technical changes without notice.

CORTINA

MODIFIED: 19/05/16 fd

STANDARD HARDWARE

STANDARD HARDWARE



CSI-6

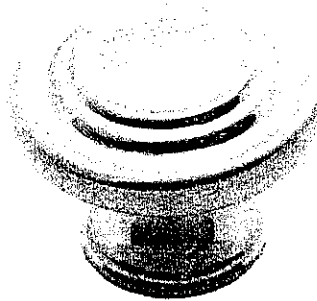

CSI-10

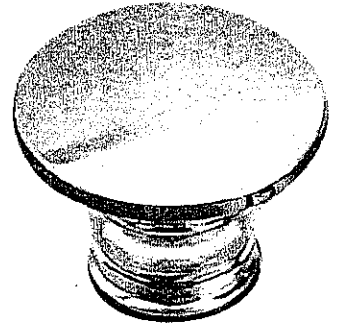

CSI-14



CSI-16



CSI-18

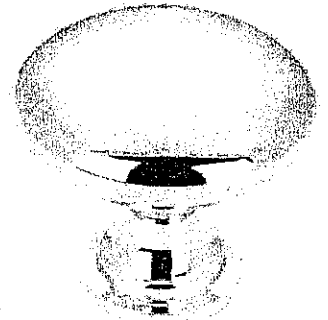

CSI-19

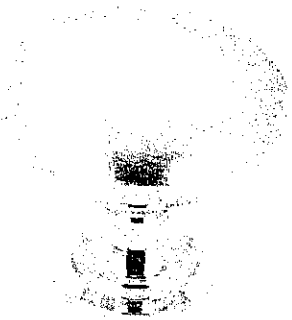

CSI-20

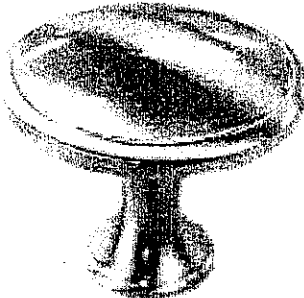

CSI-21

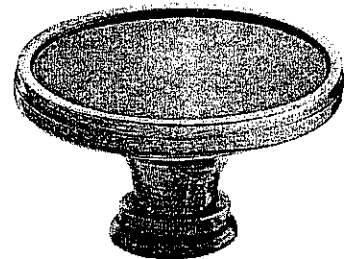

CSI-22

KITCHEN + MASTER ENSUITE

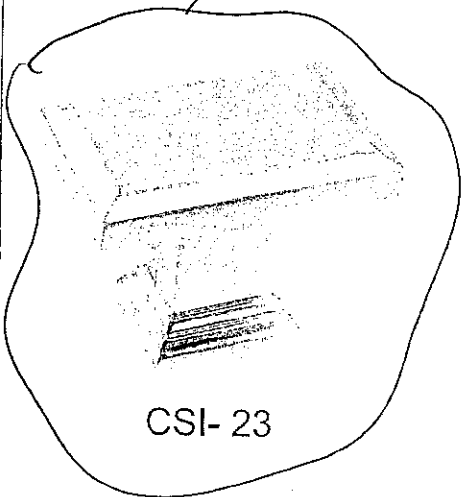

CSI-23

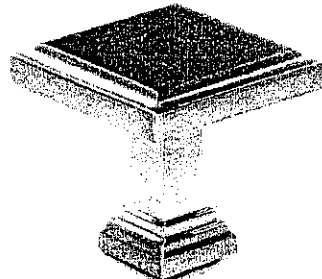

CSI-24

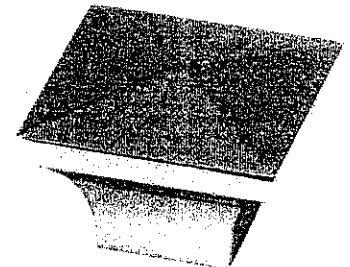

CSI-25

***NOTES:**

- IMAGES ARE FOR QUICK REFERENCE PURPOSES ONLY
- ACTUAL SIZES AND FINISHES AS PER HARDWARE SAMPLE BOARD PROVIDED TO DECOR CENTRE

*N/A FOR
ENSUITEZ
+
TWIN BATH*

K62-14



MAR. 23, 2017

- Standard 2CM & 3CM
- ◐ Upgrade 1 2CM & 3CM
- ◑ Upgrade 1 4 CM
- Upgrade 2

20mm (3/4") Profiles

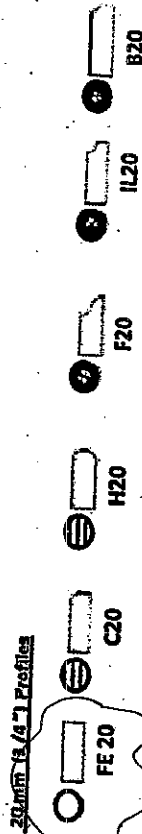

30mm (1 1/4") Profiles

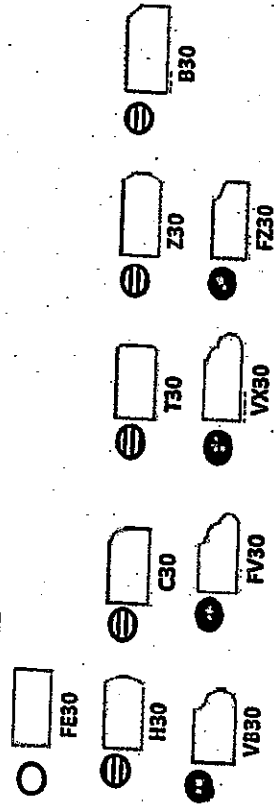

KITCHEN
(STO SINK)

MASTER ENSUITE
(CURB SINKS)

40mm (1 1/2") Profiles

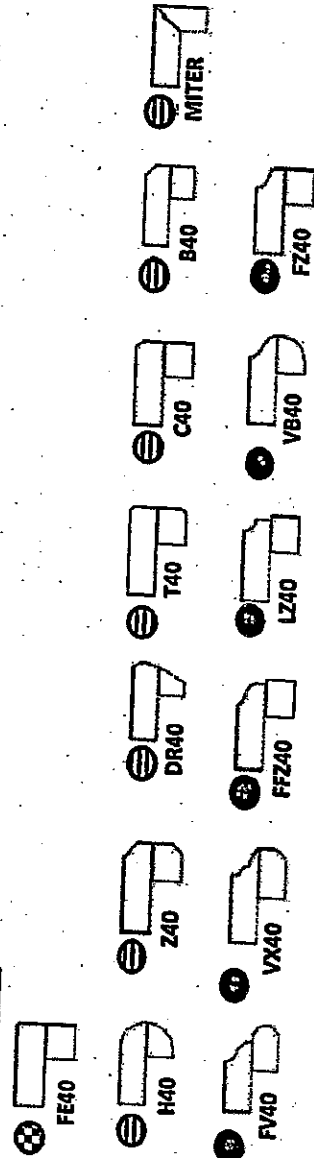

Note: All colours may not be available in 30mm at time ordered. Vendor reserves the right to use 40 mm edges (by lamination process).

*Mitre edge is available in Upgrade 1 for an overall thickness of 2". All other Mitre edge options will be an Upgrade 2 Edge.

K62-14

MARCH 23, 2017

Arzo 3 Piece Roman Tub (chrome) #T2786/R2709

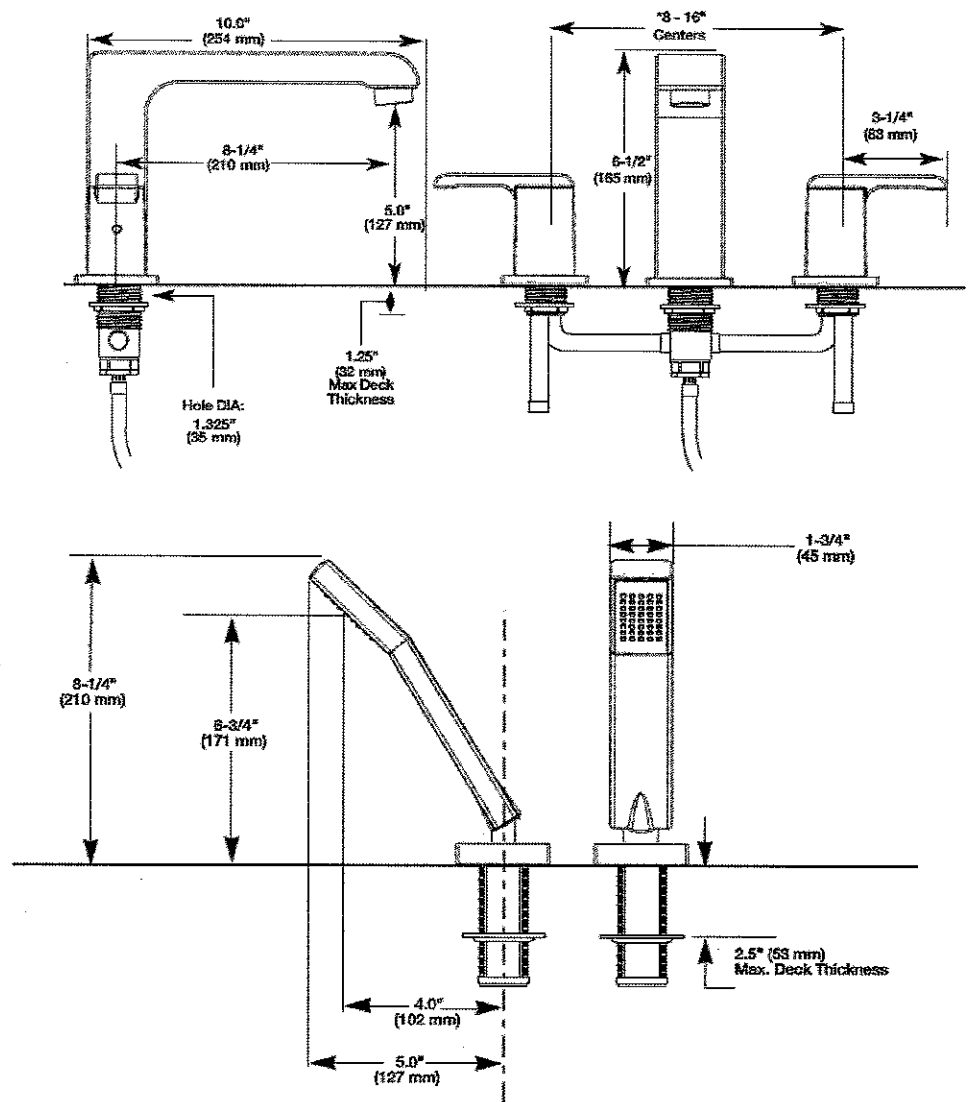
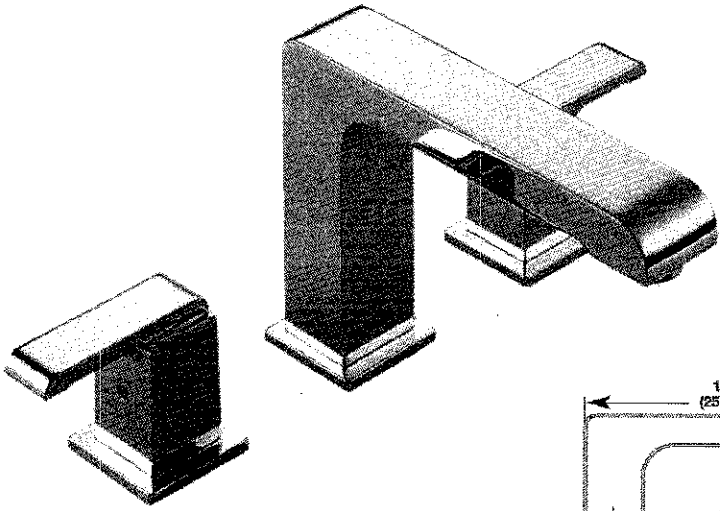

LOT #	
K62-14	
ROOM:	SIGNATURE:
MASTER ENSUITE TUB	<i>[Signature]</i>
DATE:	SIGNATURE:
MARCH 23, 2017	<i>[Signature]</i>

Conrac 'Camden' square under mount sink (white) #4210CHY

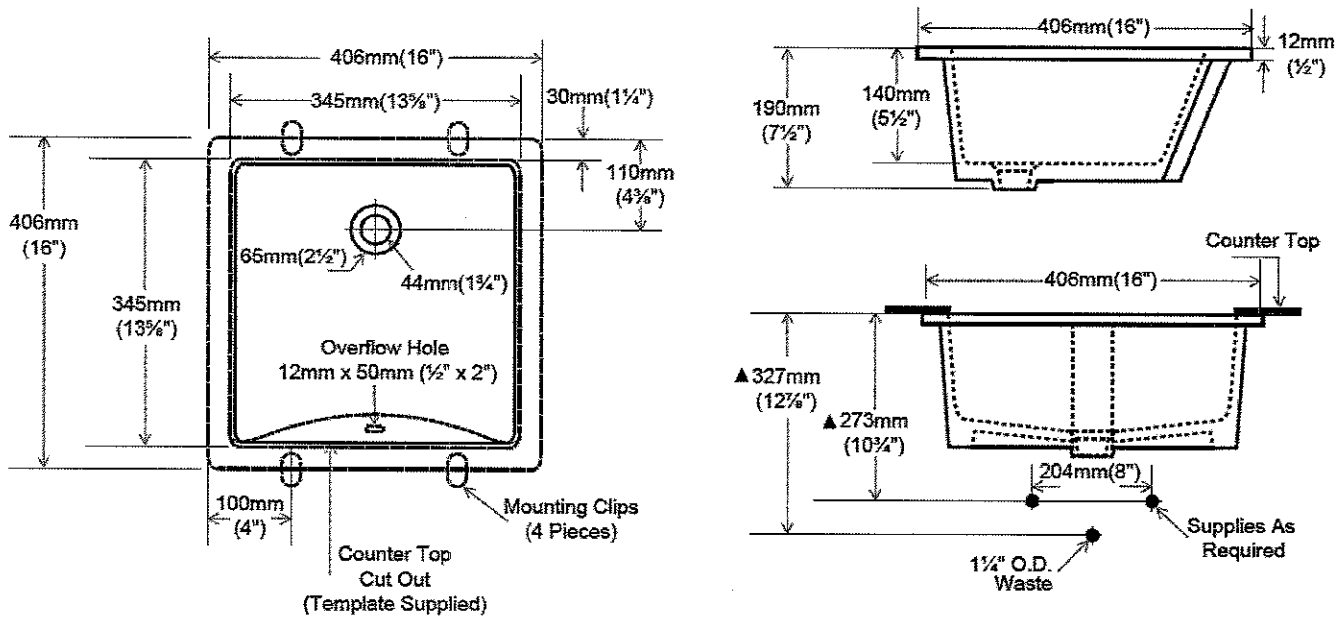
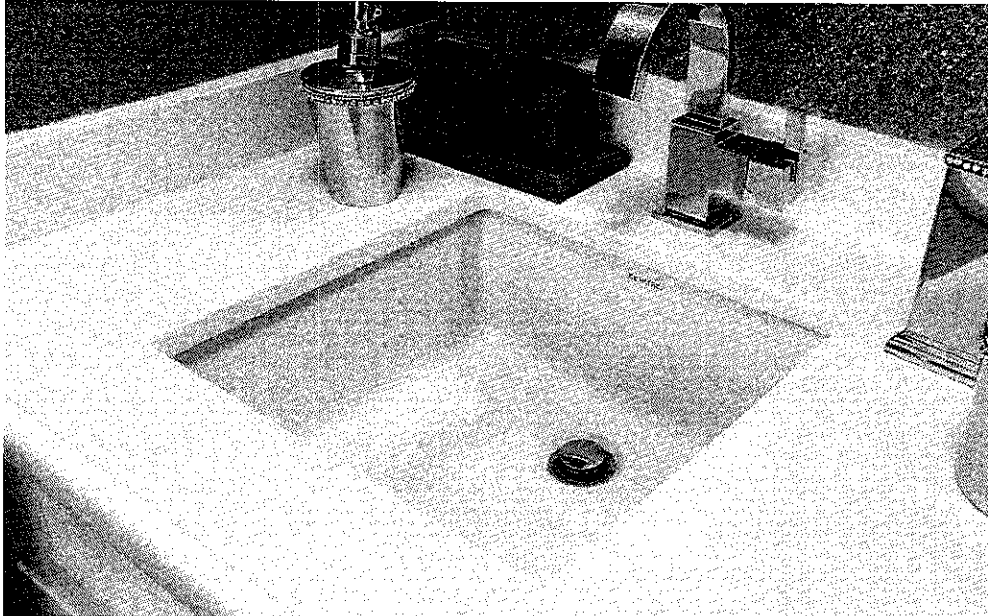

LOT #
K62-14

ROOM:
MASTER ENSUITE X2

SIGNATURE:
[Handwritten Signature]

DATE:
MAR 23, 2017

SIGNATURE:
[Handwritten Signature]

Arzo TempAssure 3 Function Shower System

#T17T267/50570//T11867/R1100/R10000-UNBXHF (chrome)

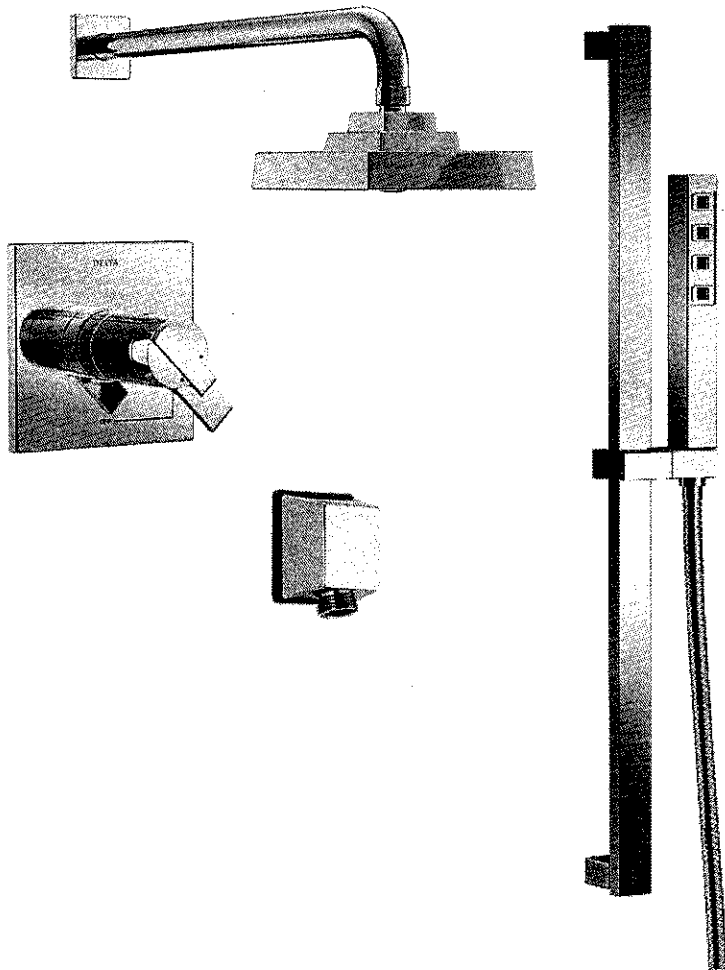
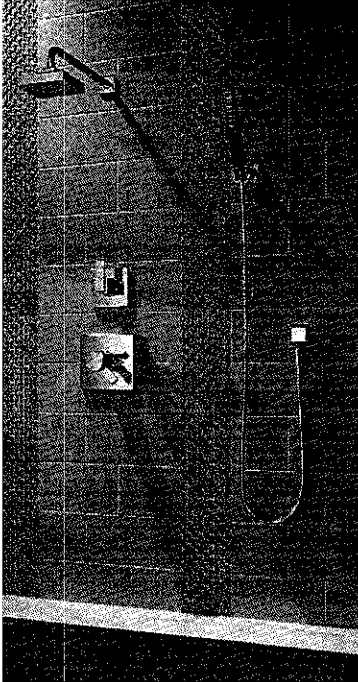

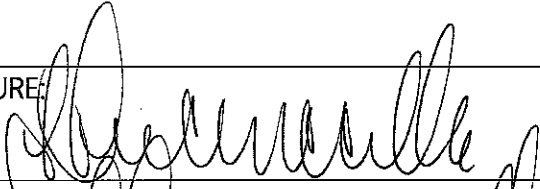
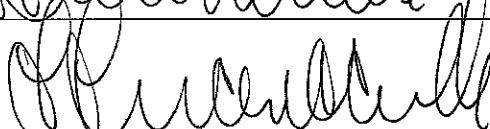
LOT # K62-14	
ROOM: MASTER ENSUITE	SIGNATURE: 
DATE: MARCH 23, 2017	SIGNATURE: 

Arzo single lever lav faucet (chrome) #586LF-MPU

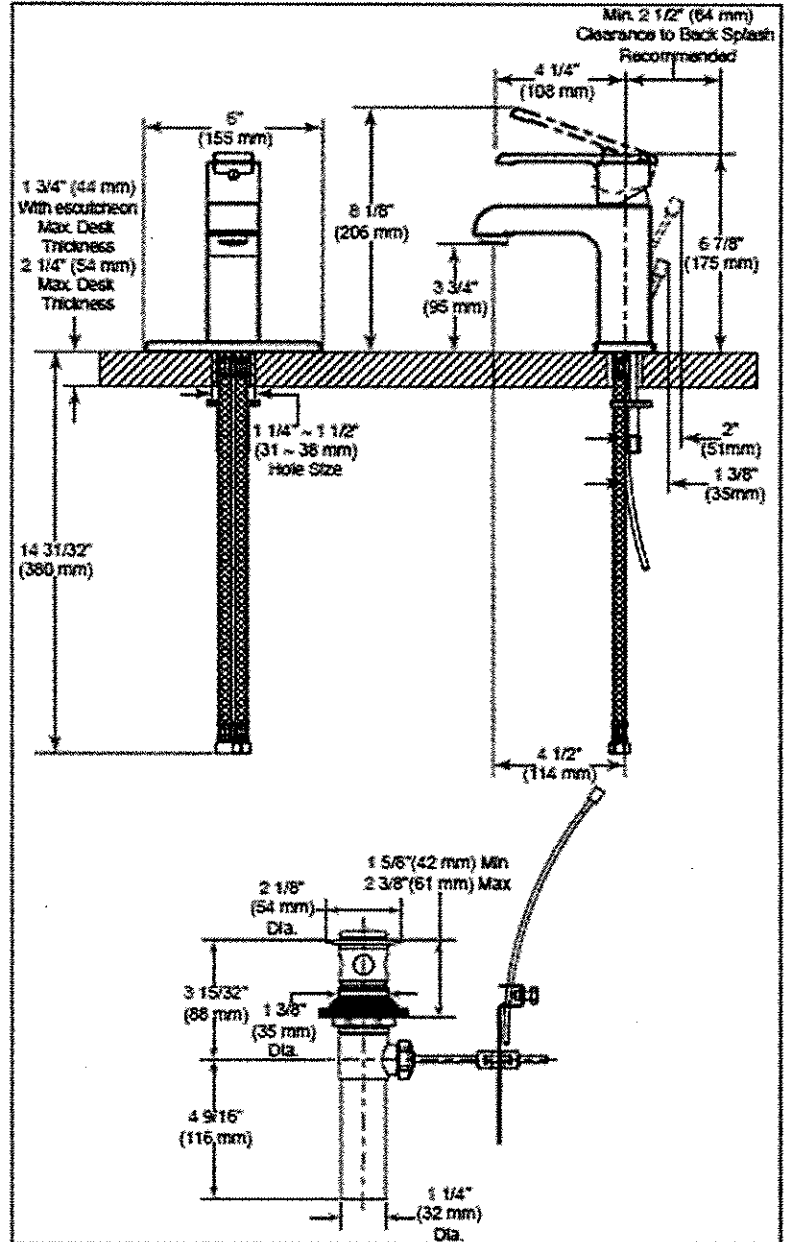
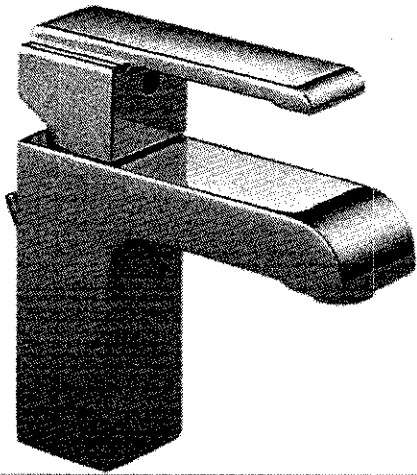

LOT #
KG2-14

ROOM: MASTER ENSUITE
X2

SIGNATURE: *[Handwritten Signature]*

DATE:
March 23, 2017

SIGNATURE: *[Handwritten Signature]*

FOREMOST.

Marleau
24" Vanity Combo

Specifications:

- 2 Slow close drawers
- Carved drawer pulls
- Assembled vanity
- White vitreous china sink included
- Single hole faucet drilling
- Pre-attached mounting system
- Faucet not included

Overall Dimensions:

24" (W) x 18" (D) x 20 3/8" (H)

Shipping:

Cube 10.24
GW 93.5 lbs

SEE BELOW

Item to be specified:

~~Ash Grey:~~

~~MAAG2318~~
UPC: 721015423584

High Gloss Grey:

MAHG2318
UPC: 721015423607

~~White:~~

~~MAWA2318~~
UPC: 721015423935

TOP
INCLUDED

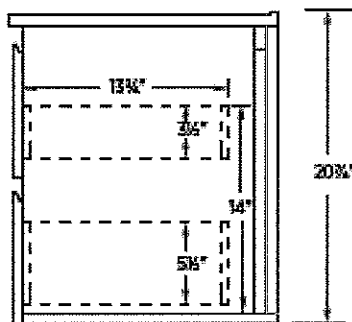
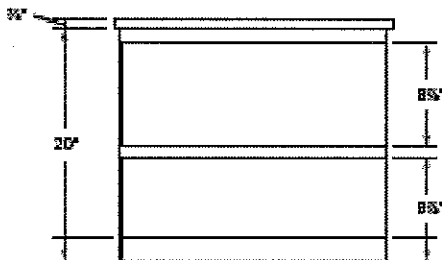
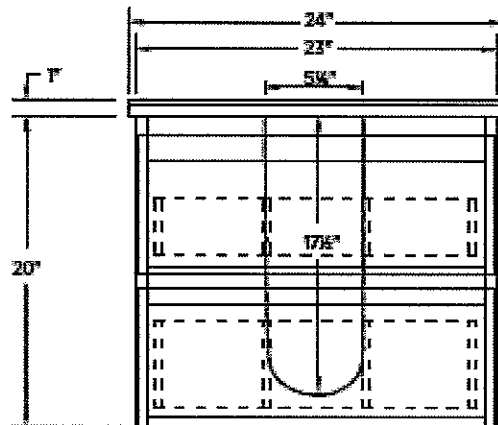
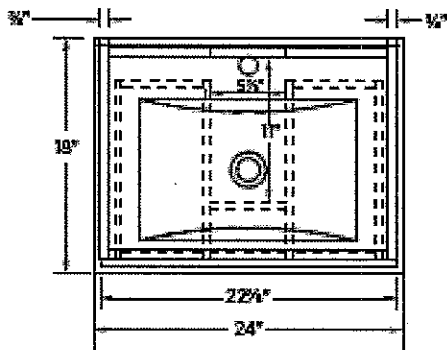
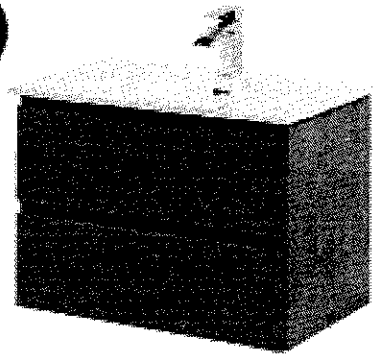

Rough in dimensions

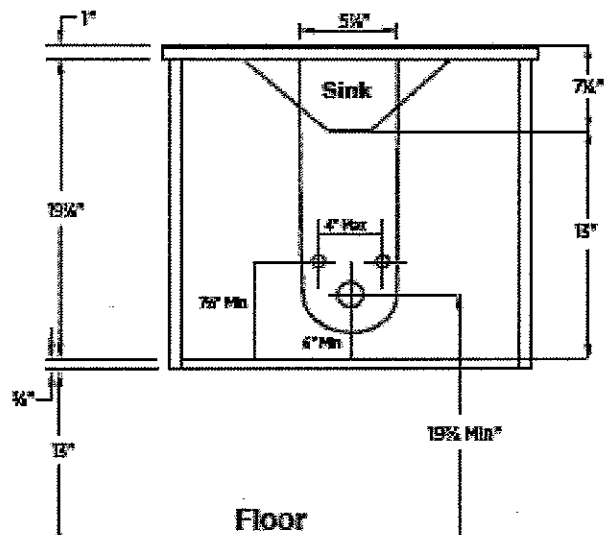

Notes:

Important: Dimensions of product are nominal and may vary within the range of tolerances allowed. These measurements are subject to change or cancellation. No responsibility is assumed for use of superseded or voided pages.

LOT #
K62-14

ROOM:

HIGH GLOSS GREY
POWDER RM (X1)

SIGNATURE:

DATE:
MARCH 23, 2017

SIGNATURE:

Kleinburg
GLEN

the Hampton

Elevation A • 2,388 sq.ft.

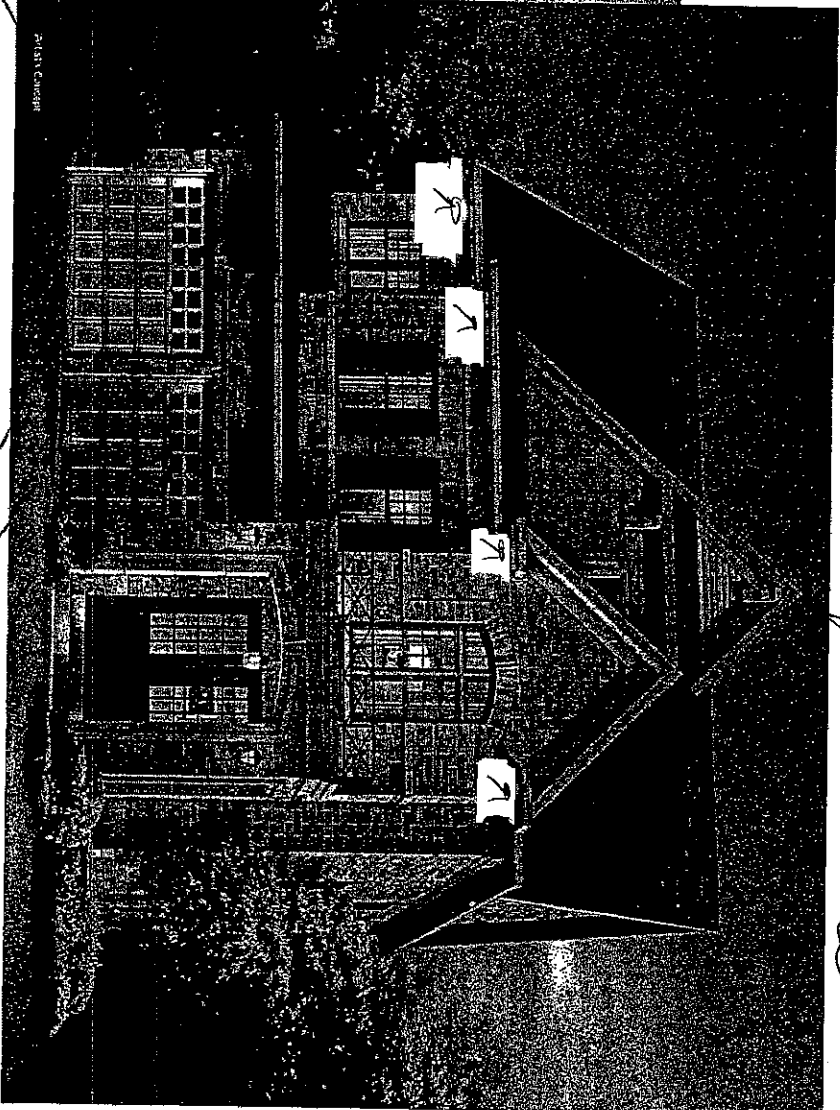
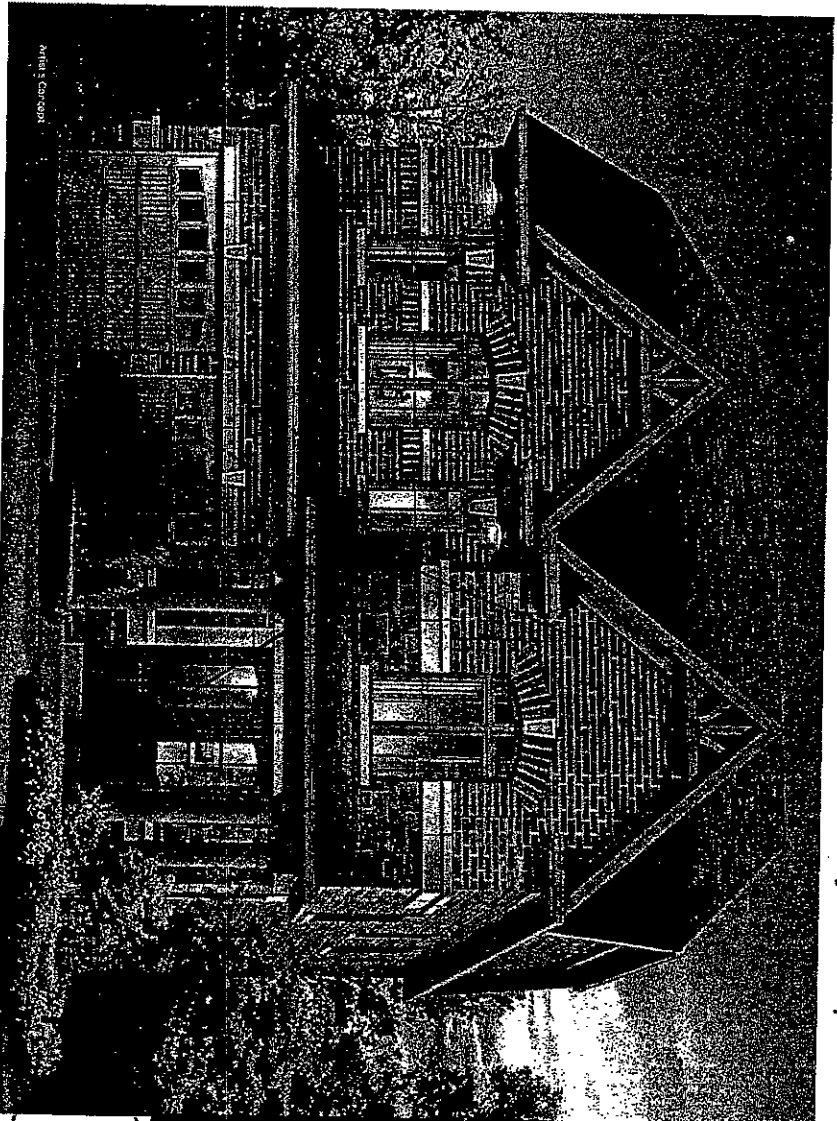

Elevation B • 2,375 sq.ft.

SCHEDULE 'E'

SOFFIT LED POUTLIGHTS
4

GOLDPARK
HOMES

K&L-14
SILVERMOUNT
+
COURTESY
INTEREST-23/2017

Lot #14
September 24, 2016

VENDOR
PURCHASER
PURCHASER